

**OPERATOR'S
MANUAL
AVCO LYCOMING
O-340 SERIES
AIRCRAFT ENGINES**

Approved by F.A.A. June 1975

2nd Edition

Part No. 60297-3

Price \$5.00

 **AVCO** LYCOMING DIVISION
WILLIAMSPORT, PENNSYLVANIA

Printed in U.S.A.

LYCOMING OPERATOR'S MANUAL

ATTENTION

OWNERS, OPERATORS, AND MAINTENANCE PERSONNEL

This operator's manual contains a description of the engine, its specifications, and detailed information on how to operate and maintain it. Such maintenance procedures that may be required in conjunction with periodic inspections are also included. This manual is intended for use by owners, pilots and maintenance personnel responsible for care of Avco Lycoming powered aircraft. Modifications and repair procedures are contained in Avco Lycoming overhaul manuals; maintenance personnel should refer to these for such procedures.

SAFETY WARNING

Neglecting to follow the operating instructions and to carry out periodic maintenance procedures can result in poor engine performance and power loss. Also, if power and speed limitations specified in this manual are exceeded, for any reason; damage to the engine and personal injury can happen. Consult your local FAA approved maintenance facility.

SERVICE BULLETINS, INSTRUCTIONS, AND LETTERS

Although the information contained in this manual is up-to-date at time of publication, users are urged to keep abreast of later information through Avco Lycoming Service Bulletins, Instructions and Service Letters which are available from all Avco Lycoming distributors or from the factory by subscription. Consult the latest edition of Service Letter No. L114 for subscription information.

SPECIAL NOTE

The illustrations, pictures and drawings shown in this publication are typical of the subject matter they portray; in no instance are they to be interpreted as examples of any specific engine, equipment or part thereof.

LYCOMING OPERATOR'S MANUAL

IMPORTANT SAFETY NOTICE

Proper service and repair is essential to increase the safe, reliable operation of all aircraft engines. The service procedures recommended by Lycoming are effective methods for performing service operations. Some of these service operations require the use of tools specially designed for the task. These special tools must be used when and as recommended.

It is important to note that most Lycoming publications contain various Warnings and Cautions which must be carefully read in order to minimize the risk of personal injury or the use of improper service methods that may damage the engine or render it unsafe.

It is also important to understand that these Warnings and Cautions are not all inclusive. Lycoming could not possibly know, evaluate or advise the service trade of all conceivable ways in which service might be done or of the possible hazardous consequences that may be involved. Accordingly, anyone who uses a service procedure must first satisfy themselves thoroughly that neither their safety nor aircraft safety will be jeopardized by the service procedure they select.

 **LYCOMING OPERATOR'S MANUAL**

TABLE OF CONTENTS

		Page
SECTION 1	DESCRIPTION	1-1
SECTION 2	SPECIFICATIONS	2-1
SECTION 3	OPERATING INSTRUCTIONS	3-1
SECTION 4	PERIODIC INSPECTION	4-1
SECTION 5	MAINTENANCE PROCEDURES	5-1
SECTION 6	TROUBLE-SHOOTING	6-1
SECTION 7	INSTALLATION AND STORAGE	7-1
SECTION 8	TABLES	8-1

AVCO LYCOMING OPERATOR'S MANUAL

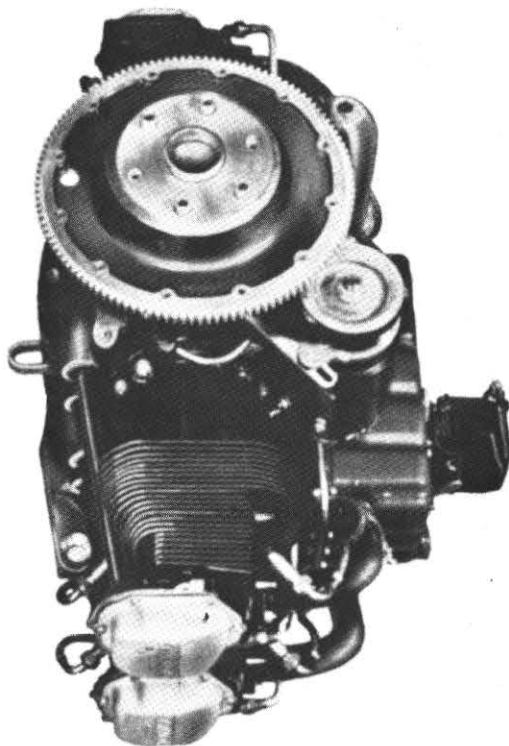

3/4 Front View - O-340-A1A

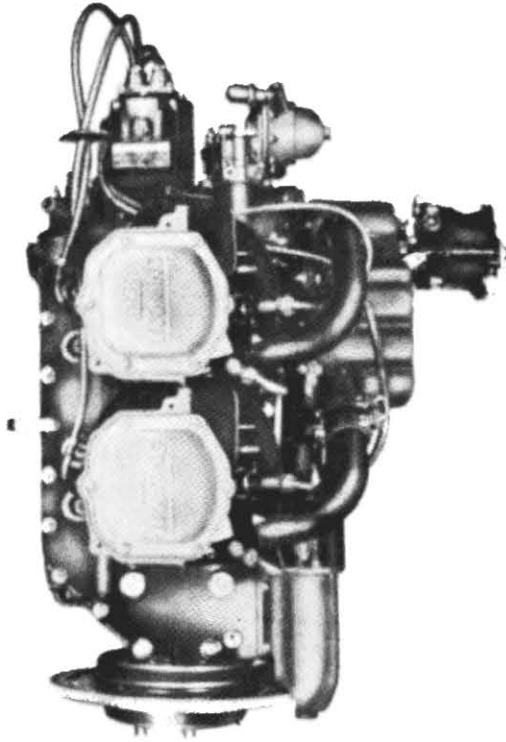

Left Side View - O-340-A1A

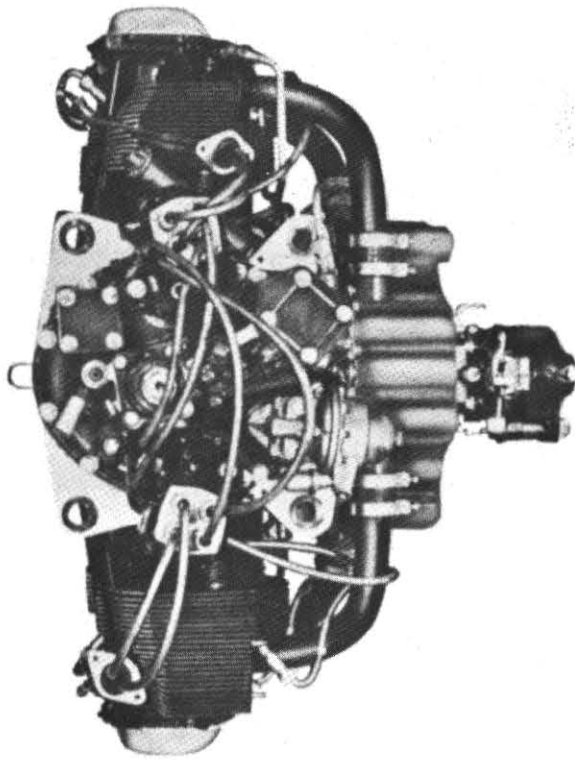

Rear View - O-340-A1A

DESCRIPTION

	Page
General	1-1
Cylinders	1-1
Valve Operating Mechanism	1-1
Crankshaft	1-2
Crankcase	1-2
Oil Sump	1-2
Connecting Rods	1-2
Pistons	1-2
Accessory Housing	1-2
Gears	1-2
Cooling System	1-3
Lubrication System	1-3
Induction System	1-4
Ignition System	1-4
Generator and Starter	1-4
Accessory Drives	1-4

SECTION 1

DESCRIPTION

General - The Avco Lycoming O-340-A1A aircraft engine is a four cylinder wet sump, horizontally opposed model. The cylinders are not directly opposite from each other but are staggered, thus permitting a separate throw on the crankshaft for each connecting rod.

Cylinders - The cylinders are of conventional air cooled design with the two major parts, head and barrel, screwed and shrunk together. The heads are made from an aluminum alloy casting with a fully machined combustion chamber. The cylinder barrel, which is machined from a chrome nickel molybdenum steel forging with deep integral cooling fins, is ground and honed to a specified finish.

NOTE

Standard engines are furnished with unplated cylinder barrels and chrome plated piston rings. Engines rebuilt with chrome plated barrels require unplated piston rings.

The valve rocker shaft bearing supports and the rocker box housing are cast integrally with the cylinder head. The valves are cooled by means of fins which completely surround the area of the exhaust valve and portions of the intake valve. A sodium-cooled rotator type exhaust valve is employed on this engine. Bronze valve guides and austenitic chrome nickel steel valve seats are shrunk into machined recesses in the head.

WARNING

Do not under any circumstances assemble chrome plated piston rings in a chrome plated cylinder barrel. Chrome plated cylinders are identified by the fin area between the spark plug hole and the cylinder barrel painted orange. Consult Service Instruction No. 1181.

Valve Operating Mechanism - The valve operating mechanism is located on the top side of the engine, facilitating proper lubrication and easy accessibility. The camshaft is located parallel to and above the crankshaft and operates in aluminum bearings. The camshaft in turn actuates the valves by means of mushroom type hydraulic tappets, which automatically keep the valve clearance at zero. The valve rockers are supported on a full floating steel pin. The valve springs bear against both upper and lower steel seats and are retained on the valve stems by means of split keys.

LYCOMING OPERATOR'S MANUAL

SECTION 1

O-340-A1A

Crankshaft - The crankshaft is made from a chrome nickel molybdenum steel forging. All bearing journal surfaces are nitrided, and centrifugal sludge removers are provided in the form of oil tubes at each crankpin journal. These tubes can easily be removed during overhaul of the engine and accumulated sludge cleaned out.

NOTE

Crankshafts on standard O-340-A1A engines, which are equipped for fixed pitch operation, are not interchangeable with crankshafts furnished with O-320-A1A engines equipped to operate with constant speed propeller governors.

Crankcase - The crankcase assembly consists of two reinforced aluminum alloy castings divided vertically at the center line of the engine and fastened together by means of through bolts and nuts. The mating surfaces of the crankcase are joined without the use of a gasket, and the main bearing bores are machined for use of precision type main bearing inserts.

Oil Sump - The oil sump incorporates an oil screen filter, carburetor mounting pad, the intake riser, and the intake pipe connections. The fuel air mixture, as it passes through the riser, is vaporized by the heated oil in the sump that surrounds the riser.

Connecting Rods - The connecting rods are made in the form of "H" sections from alloy steel forgings. They have replaceable bearing inserts in the crankshaft ends and split type bronze bushings in the piston ends. The bearing caps on the crankshaft ends of the rods are retained by means of two bolts and nuts through each cap.

Pistons - The pistons are machined from aluminum alloy and their general construction is of the full skirt type. Two compression rings and an oil regulator ring are located above the piston pin. The piston pin is of the full floating type with an aluminum plug located at each end to prevent the pin from touching the cylinder wall.

Accessory Housing - The accessory housing is made from an aluminum casting and is fastened to the rear of the crankcase and the top rear of the sump. It forms a housing for the oil pump and the drives for the tachometer, magnetos, and other accessories.

Gears - The gears are of the conventional spur type and are precision machined. They are hardened to insure long life and satisfactory operating qualities.

AVCO LYCOMING OPERATOR'S MANUAL

O-340-A1A

SECTION 1

Cooling System - The air pressure cooling system is actuated by the forward speed of the plane. Baffles are provided to build up a pressure between the cowling and the top of the cylinders, thus forcing the cool air down through the cylinder fins. The air is then exhausted through gills or augmentor tubes usually located at the rear of the engine cowling.

Lubrication System - The lubrication system is of the pressure wet sump type. The main bearings, connecting rod bearings, camshaft bearings, valve tappets, and push rods are lubricated by positive pressure. Piston pins, gears, cylinder walls, and other parts are lubricated by means of oil collectors and spray. The oil pump, which is located in the accessory housing, draws oil through a tube from an oil suction screen located in the sump. The oil from the pump then enters a drilled passage in the accessory housing, which feeds the oil to a threaded connection on the rear face of the accessory housing, where a flexible line leads the oil to the external oil cooler. Pressure oil from the cooler returns to a second threaded connection on the accessory housing, from which point a drilled passage conducts the oil to the oil pressure screen, which is contained in a cast chamber mounted on the accessory housing. In the event that cold oil or an obstruction should restrict the flow of oil to the cooler, an oil cooler bypass valve is provided to pass the pressure oil directly from the oil pump to the oil pressure screen chamber.

The oil pressure screen is provided as a means to filter from the oil any solid particles that may have passed through the suction screen in the sump. After being filtered in the pressure screen chamber, the oil is fed through a drilled passage to the oil pressure relief valve, located in the upper right side of the crankcase in front of the accessory housing.

This relief valve regulates the engine oil pressure by allowing excessive oil to return to the sump, while the balance of the pressure oil is fed to the main oil gallery in the right half of the crankcase. During its travel through this main gallery, the oil is distributed by means of separate drilled passages to the main bearings of the crankshaft. The drilled passages to the bearings are located in such a manner as to form an inertia type filter. Thus, only the cleanest oil will be fed to the bearings. Separate passages from the rear main bearing supply pressure oil to both crankshaft idler gears. Angular holes are drilled through the main bearings to the rod journals where sludge removal tubes are located. Here the centrifugal force of the crankshaft removes any sludge or heavy matter that may be present in the oil. Oil from main oil gallery also flows to the cam and valve gear passages, and is then conducted through branch passages to the hydraulic tappets and camshaft bearings. Oil enters the tappets through indexing holes and travels out through the hollow push rods to the valve mechanism, lubricating the valve rocker bearings and valve stems. Residual oil from the bearings, accessory drives, and rocker boxes is returned by gravity to the sump, where after passing through a screen it is again circulated through the engine.

LYCOMING OPERATOR'S MANUAL

SECTION 1

O-340-A1A

Induction System - The Avco Lycoming O-340-A1A engine is equipped with a Marvel-Schebler model MA-4-5 carburetor. This carburetor is of the single barrel float type, and is equipped with a manual altitude mixture control and an idle cut-off. Particularly good distribution of the fuel air mixture to each cylinder is obtained by the center zone induction system, which is integral with the oil sump and is submerged in oil, insuring a more uniform vaporization of fuel and aiding in cooling the oil in the sump. From the riser the fuel air mixture is distributed to each cylinder by separate steel intake pipes.

Ignition System - Dual ignition is furnished by two Scintilla magnetos; the left magneto incorporates an impulse coupling. The ignition wiring is so arranged that the left magneto (S4LN-21) fires the top plugs in the left hand cylinders and the bottom plugs of the right hand cylinders, while the right magneto (S4LN-20) fires the bottom plugs of the left hand cylinders and the top plugs of the right hand cylinders. (See wiring diagram on page 5-2. This arrangement insures consistent drop-off when switching from both magnetos to either the right or left magneto.

Generator and Starter - The starter is located in the lower left front side of the engine, and its Bendix type drive engages with a gear that is integral with the rear propeller flange, while the generator is located on the lower right front side of the engine and is driven by a belt to a pulley which is concentric with and integral to the rear propeller flange. Where required for twin engine installations, special regulators and paralleling relays can be provided for parallel operation of the generators. Although a 12 volt starter and generator are furnished as standard equipment, a choice of several current ratings in 12 and 24 volt generators is available.

Accessory Drives - In addition to the magneto, starter, and generator drives previously mentioned, the standard O-340-A1A engine is furnished with an SAE type tachometer drive. Optional drives available include an AN20010 propeller governor drive, vacuum pump drive, and a choice of a geared or plunger operated fuel pump drive. An AC Type AH diaphragm fuel pump is also available as optional equipment when the plunger type fuel pump drive is supplied.

 **LYCOMING OPERATOR'S MANUAL**

SPECIFICATIONS

	Page
Specifications - O-340-A1A2-1
Detail Weights2-2
Accessory Drives2-2

SECTION 2
SPECIFICATIONS

O-340-A1A

FAA Type Certificate	277
Rated Horsepower	170
Rated RPM	2700
Cruising RPM	
Economy	2350
Performance	2450
Bore	5-1/8 in.
Stroke	4-1/8 in.
Compression Ratio	8.50:1
Piston Displacement - Cubic Inches	340.4
Head Temperature, Max. °F.	
(at Bayonet Location)	500
Barrel Temperature, Max. °F.	
(at Fillet of Base Flange)	325
Fuel Octane	91/96
Oil Sump Capacity - Quarts	8
Oil Sump—Safe Minimum Quantity—Quarts	2
Oil Pressure Minimum Idling—(Lbs.per Sq.In.)	25
Normal Operating—(Lbs.per Sq.In.)60 to 85
Crankshaft Rotation—	
Viewed from Propeller End	Counter-Clockwise
Valve Rocker Clearance	
(Hydraulic Tappets Collapsed)028-.080 in.
Spark Occurs, Degrees BTC	25
Spark Plug Gap—Shielded024-.027 in.
Firing Order	1-3-2-4

AVCO LYCOMING OPERATOR'S MANUAL

SECTION 2

O-340-A1A

SPECIFICATIONS

Detail Weight - Standard Engine (dry); includes 12V. 20Amp Generator (10.64 lbs.) and Starter—Average.

Engine - O-340-A1A	278 lbs.
Engine Attaching Parts	1.35 lbs.
Propeller Attaching Parts	2.00 lbs.

Optional -

Fuel Pump Drive (AN type)	2.25 lbs.
Fuel Pump Drive (Plunger type)14 lbs.
Vacuum Pump Drive85 lbs.
Propeller Governor Drive	2.20 lbs.
Generator (12V. 35 Amp)	16.60 lbs.
Generator (24V. 15 Amp)	16.00 lbs.
Generator (24V. 25 Amp)	20.75 lbs.
Shielded Harness, Breeze or equivalent—subtract30 lbs.
Cooling Baffles	1.20 lbs.

Accessory Drive	Gear Ratio	*Direction of Rotation
Generator	1.19:1	Clockwise
Propeller Governor**	.866:1	Clockwise
Vacuum Pump**	1.300:1	Counter-Clockwise
Starter	13.556:1	Counter-Clockwise
Tachometer	.500:1	Clockwise
Fuel Pump**	.866:1	Counter-Clockwise
Fuel Pump (Plunger Operated)**	.500:1	
Magnetos	1.00:1	Clockwise

* - Viewed from rear of engine.

** - Optional

OPERATING INSTRUCTIONS

	Page
General3-1
Engine Flight Chart3-1
Operating Conditions3-2
Prestarting Inspection3-2
Care of a New Engine3-3
Starting Procedure3-3
Cold Weather Starting3-3
Ground Running and Warm-Up3-4
Ground Test3-4
Operation in Flight3-4

AVCO LYCOMING OPERATOR'S MANUAL

O-340-A1A

SECTION 3

SECTION 3

OPERATING INSTRUCTIONS

General - Close adherence to these instructions will greatly contribute to long life, economy, and satisfactory operation of the engine.

NOTE

YOUR ATTENTION IS DIRECTED IN PARTICULAR TO THE WARRANTIES THAT APPEAR IN THE FRONT OF THIS MANUAL REGARDING ENGINE SPEED, THE USE OF SPECIFIED FUELS AND LUBRICANTS, REPAIRS AND ALTERATIONS. PERHAPS NO OTHER ITEM OF ENGINE OPERATION AND MAINTENANCE CONTRIBUTES QUITE SO MUCH TO SATISFACTORY PERFORMANCE AND LONG LIFE AS THE CONSTANT USE OF CORRECT GRADES OF FUEL AND OIL, CORRECT ENGINE TIMING, AND FLYING THE AIRPLANE AT ALL TIMES WITHIN THE SPEED AND POWER RANGE SPECIFIED FOR THE ENGINE. DO NOT FORGET THAT VIOLATION OF THE OPERATION AND MAINTENANCE SPECIFICATIONS FOR YOUR ENGINE WILL NOT ONLY VOID YOUR WARRANTY BUT WILL SHORTEN THE LIFE OF YOUR ENGINE AFTER ITS WARRANTY PERIOD HAS PASSED.

Engine Flight Chart

Fuel - This engine is designed to operate on 91/96 octane aviation fuel. Under no circumstances should automotive fuel be used (regardless of octane rating). Refer to the latest edition of Service Instruction No. 1070 for further fuel information.

***Recommended Grade Oil**

Average Ambient Air	MIL-L-60828 Grades	MIL-L-22851 Ashless Dispersant Grades
Above 60°F.	SAE 50	SAE 40 or SAE 50
30° to 90°F.	SAE 40	SAE 40
0° to 70°F.	SAE 30	SAE 40 or SAE 30
Below 10°F.	SAE 20	SAE 30

* - Refer to the latest edition of Service Instruction No. 1014.

Oil Sump Capacity 8 U. S. Quarts
Minimum Safe Quantity in Sump 2 U. S. Quarts

OPERATING CONDITIONS

Average Ambient Air	Oil Inlet Temperature	
	Desired	Maximum
Above 60°F.	180°F. (82°C.)	245°F. (118°C.)
30° to 90°F.	180°F. (82°C.)	245°F. (118°C.)
0° to 70°F.	170°F. (77°C.)	225°F. (107°C.)
Below 10°F.	160°F. (71°C.)	210°F. (99°C.)

Minimum Oil Temperature for Continuous Engine Operation 140° (60°C.)

Oil pressure,normal psi 85 max. 60 min. 25 idling

Fuel Pressure,psi 5.0 max. 3.0 desired .5 min.

Maximum Cylinder Head Temperature

At bayonet thermocouple location	500°F.
Take-off and Climb	500°F.
Cruising	450°F.

2. *Prestarting Inspection* - Following installation after a prolonged period of idleness:

- a. Check ground wires on magnetos.
- b. Be sure ignition switch is in the "OFF" position.
- c. Inspect mounting and propeller bolts for proper tightness and safety.
- d. Turn propeller over by hand five or six full revolutions, checking airplane and engine clearance.
- e. Check oil level in sump.
- f. See that fuel tanks are full.
- g. Operate all controls and check travel for full range and freedom from binding.
- h. Clean the fuel strainer and drain sufficient fuel to clear out any foreign matter.
- i. Check baffles and cowling for security.

 LYCOMING OPERATOR'S MANUAL

O-340-A1A

SECTION 3

3. Care of a New Engine - A new engine has been carefully run-in and has passed a rigid final test at the factory, and no further "Break-In" is necessary, but the operator will benefit by treating it carefully during its first few hours in service. Avoid prolonged operation at full throttle or excessive engine speeds.

4. Starting Procedure - After completion of prestarting inspection:

- a. Head the airplane into the wind.
- b. Lock the wheels by either wheel brakes or chocks.
- c. Turn fuel valve to "ON" position.
- d. Move mixture control lever to "FULL RICH".
- e. Set throttle to 1/10 open position.
- f. Prime cold cylinders with one to three full strokes of priming pump depending on engine temperature.
- g. Engage starter and allow engine to turn approximately one full turn before turning ignition switch to the "LEFT MAG" position.

NOTE

Starter manufacturers recommend that cranking periods be limited to ten to twelve seconds with a five minute rest between cranking periods. Longer cranking periods will shorten the life of the starter.

- h. When engine fires evenly, turn ignition switch to "BOTH" and open throttle to an indicated speed of 800 RPM. Check oil pressure gage for an indicated pressure. If oil pressure is not indicated within one-half minute, stop engine and determine trouble.

5. Cold Weather Starting - During extreme cold weather it may be necessary to preheat the engine or the oil before starting. If engine fails to start at the first attempt, another attempt should be made without priming. If this fails it is possible that the engine is overprimed, turn switch to "OFF" position, open throttle slowly, and turn the engine over approximately ten revolutions. Prime with half the original prime and repeat starting procedure. If this fails, refer to Section 6 on Engine Troubles.

 **LYCOMING OPERATOR'S MANUAL**

SECTION 3

O-340-A1A

6. Ground Running and Warm-Up - The Avco Lycoming O-340-A1A is an air pressure cooled engine that depends on the forward speed of the airplane to maintain proper cooling. Therefore, particular care is necessary when operating this engine on the ground. To prevent overheating it is recommended that the following precautions be followed:

- a. Head airplane into the wind.
- b. Avoid prolonged idling at low RPM as this practice may result in fouled spark plugs.
- c. Do not exceed 1800 RPM during ground test.
- d. Limit ground running to 4 minutes in cold weather and to 2 minutes at temperatures above 70°F.

NOTE

Engine is warm enough for take-off when the throttle can be opened without back-firing or skipping of the engine.

7. Ground Test

- a. Warm up engine 800 to 1200 RPM.
- b. With engine running at 1800 RPM, switch from both magnetos to only one and check drop-off. Then switch to the other magneto and again note drop-off. Drop-off should not exceed 125 RPM on either magneto. On planes with controllable pitch props the drop-off should not exceed 125 RPM when engine is turning 2000 RPM with manifold pressure of 15 in. hg.
- c. Check both oil pressure and oil temperature.
- d. Take-off as soon as the test is completed, because excessive ground running will cause overheating.

8. Operation in Flight

- a. **Use of Carburetor Heat Control** - Under certain moist atmospheric conditions it is possible for ice to form at the carburetor even in summer weather. For complete instructions on the use of carburetor heat consult the latest publication of Service Instruction No. 1148.

 LYCOMING OPERATOR'S MANUAL

O-340-A1A

SECTION 3

b. Carburetor Mixture Control (With Fixed Pitch Prop) - The carburetor mixture control should be used to maintain the proper ratio of air and fuel when operating the engine at altitudes above 5000 feet. Under no circumstances, especially at Full Throttle, should any other position than Full-Rich Mixture be used for all flying under 5000 feet above sea level.

When flying at altitudes above 5000 feet at any throttle setting, adjust the carburetor mixture control toward the "Lean" position until the maximum engine RPM is obtained. Too lean a mixture will result in overheating with subsequent damage to the engine. Care should be taken to readjust the control for each change in the throttle setting and, particularly, to return the mixture control to the "Full-Rich" position prior to an approach for landing or a descent to a lower altitude.

c. Carburetor Mixture Control (Constant Speed Propeller) - When operating with a constant speed propeller, cylinder head temperatures (rather than engine RPM) provide a means of indicating the point of optimum economy. The recommended procedure for leaning out at cruise power (not over 75% rated power) is as follows:

NOTE

Leaning out at cruise power according to the following procedure is permissible at altitudes under 5000 feet. Under no circumstances, however, is leaning out permitted under 5000 feet at power settings in excess of 75 per cent.

Set propeller governor and engine throttle at desired RPM and manifold pressure, with altitude mixture control at "Full Rich". Allow cylinder head temperature to stabilize, and begin leaning out in small increments. While observing the cylinder head temperature indicator closely, continue to lean out until peak temperature has been reached.

CAUTION

Do not permit cylinder head temperatures to exceed 450°F.

If a sudden temperature rise occurs during leaning out, or if maximum permissible temperature is reached, the mixture control lever must be returned (toward Full Rich) to its position prior to the temperature increase.

 **LYCOMING OPERATOR'S MANUAL**

SECTION 3

O-340-A1A

d. Landing - During relatively long glides in making an approach for landing, the throttle should be partially opened at intervals to clear out engine, and the mixture control kept in full rich position to insure maximum acceleration if it should be necessary to open the throttle again.

e. Stopping the Engine - (Note: This engine is equipped with an idle cut off.) After landing, allow the engine to cool by idling for approximately one minute at 800 to 900 RPM. Then, with the engine still running at this speed, set the carburetor control at "IDLE CUT OFF". After the engine stops firing, set the ignition switch in the "OFF" position. Stopping an engine in the above method will prevent afterfiring.

f. Cold Weather Suggestions:

- (1) In extremely cold weather it may be necessary to preheat the lubricating oil prior to starting.
- (2) Avoid excessive running of engine on the ground.
- (3) To maintain the desired oil temperature, it may be necessary to block off the oil sump air blast hole or lag sump.

g. Dusty Operation - When operating from dusty fields or in a dusty location, it will be found a profitable investment to inspect carburetor air intake frequently to make sure that no air enters the carburetor except through the air cleaner.

NOTE

Inspect and service air cleaners daily according to manufacturer's instructions.

**OPERATING CONDITIONS FOR
FIXED PITCH PROPELLER**

Operation	RPM	Man. Pres.	Fuel Cons. Gal./Hr.	Max. Oil Cons. Qts./Hr.	*Max. Cyl. Head Temp.
Normal Rated	2700	28.7	15.5	.95	500°F.**
Performance Cruise	2450	24.2	10.0	.70	450°F.**
Economy Cruise	2350	22.3	8.5	.60	450°F.

* - At bayonet location.

** - Mixture control not to be used below 5000 feet.

CURVE NO. 10372 A

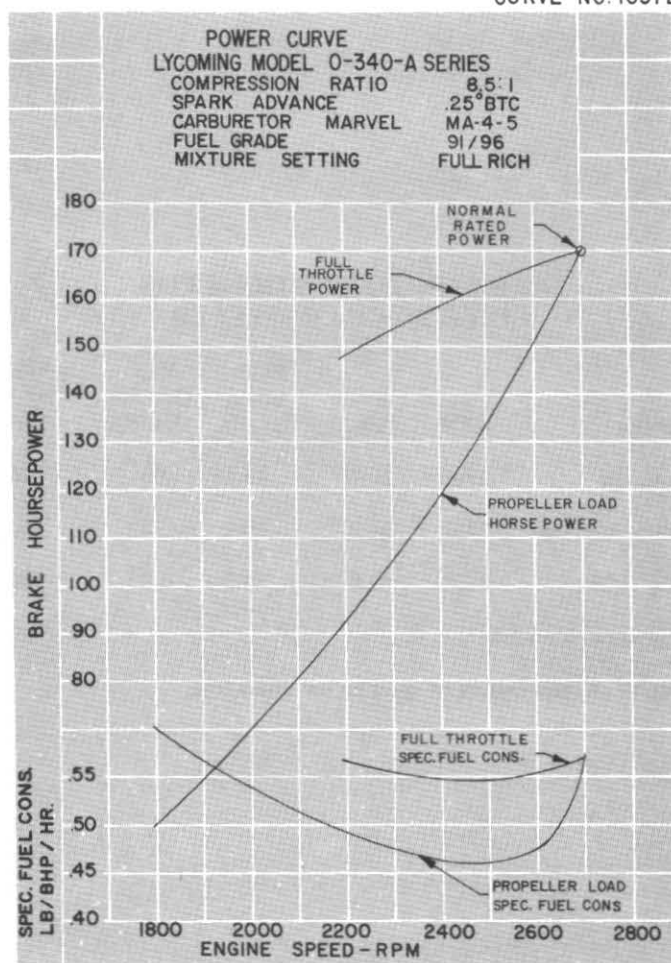

Figure 3-1. Performance Curve - O-340-A1A

PERIODIC INSPECTIONS

	Page
General	4-1
Inspection and Maintenance	
Daily Pre-Flight	4-1
50-Hour	4-1
100-Hour	4-2
Carburetor Idling Adjustment	4-3

SECTION 4

PERIODIC INSPECTIONS

1. GENERAL - The daily pre-flight inspection is a check of the complete airplane prior to the first flight of the day. This inspection is to determine the general condition of the airplane and engine, but is not designed to detect slight wear and minor maladjustments. Such items should be found during the more thorough 50-hour and 100-hour inspections.

The operator should bear in mind that the items listed in the following charts constitute a complete inspection only so far as the engine is concerned; consult the aircraft manufacturer's handbook for complete instructions.

At the conclusion of the first 25 hours of operation the engine should undergo a 50-hour inspection, including the draining and renewing of lubricating oil.

2. INSPECTION AND MAINTENANCE.

a. Daily Pre-Flight -

- (1) Check fuel and oil level.
- (2) Inspect engine for evidence of oil leakage.
- (3) Inspect safetying of oil drain plugs and covers.
- (4) Inspect carburetor and fuel line connections.
- (5) Check engine controls for general condition, travel, and free operation.
- (6) Check carburetor air cleaner. Consult per manufacturer's instructions.

b. 50-Hour

- (1) Check spark plug elbows and shielding nuts for security.

- (2) Drain carburetor bowl.
- (3) Check priming system for leaks.
- (4) Check oil lines for leaks particularly at connections, security of anchorage, wear due to rubbing or vibration, dents, and cracks.
- (5) Drain and refill oil sump with new oil.
- (6) Remove and clean suction and pressure oil strainers.
- (7) Check intake and exhaust systems for leaks and looseness.
- (8) Drain and clean fuel strainer.

NOTE

All the above operations should be performed in addition to those listed under Daily Pre-Flight.

c. 100-Hour -

- (1) Inspect all electrical wiring for general condition and proper anchorage.
- (2) Check baffles for secure anchorage, holes, cracks, bending and close fit around the cylinder.
- (3) Check cylinders for cracked or broken fins.
- (4) Check air entrances and exits for deformation.
- (5) Inspect, clean, and regap spark plugs.
- (6) Remove and clean carburetor fuel strainer.
- (7) Check magnetos for synchronization.
- (8) Check engine mounting bolts and bushings for general condition and proper torque.

 LYCOMING OPERATOR'S MANUAL

O-340-A1A

SECTION 4

NOTE

All the above operations should be performed in addition to those listed under Daily Pre-Flight and 50-Hour inspection.

d. Carburetor Idling Adjustment - With exception of the idling adjustment, no adjustment of the carburetor is necessary. The mixture is controlled by means of jets and air passages that are not adjustable and are calibrated at the factory.

To adjust the idle mixture and speed: With engine thoroughly warmed up, set throttle stop screw so that engine idles at approximately 550 RPM. Turn idle adjusting screw towards "RICH" position until engine "rolls" from richness, then turn screw slowly towards the "LEAN" position (indicated by letter "L") until engine "lags" or runs "irregularly" from leanness. This step will give an idea of the idle adjustment range and of how the engine operates under these extreme idle mixtures. From the "lean" setting, turn screw slowly towards a "richer" setting, leaving the final setting at a mixture just lean enough to prevent a rich "roll" or uneven running from richness. This adjustment will in most cases give a slower idle speed than a slightly leaner adjustment, with the same throttle stop screw setting, but will give smoothest idle operation. A change in idle mixture will change the idle speed, and it may be necessary to readjust the idle speed with the throttle stop screw to the desired point.

MAINTENANCE PROCEDURES

	Page
Oil Relief Valve5-1
Magneto Timing5-1
Cylinders	
Removal of Cylinder Assy.5-5
Removal of Valves5-5
Removal of Pistons5-6
Removal of Hydraulic Tappets5-6
Cleaning of Hydraulic Tappets5-6
Assy. of Valves5-7
Assy. of Cylinders5-8

SECTION 5

MAINTENANCE PROCEDURES

Oil Relief Valve - The function of the oil pressure relief valve, which is located between the upper right engine mounting lug and no. 3 cylinder, is to maintain engine oil pressure within specified limits by withdrawing a portion of the oil from the circulating system and returning the oil to the sump should the pressure become excessive. This valve is not adjustable; however, particles of metal or other foreign matter lodged between ball and seat will result in a drop in oil pressure. It is advisable, therefore, to disassemble, inspect, and clean the relief valve if excessive pressure fluctuations are noted.

The oil pressure relief valve is by no means to be confused with the oil cooler bypass valve, which is located on the oil pressure screen housing mounting pad. The sole purpose of the bypass valve is to serve as a safety measure, permitting pressure oil to bypass the oil cooler entirely in case of an obstruction within the cooler.

Magneto Timing - Remove the top spark plug from the no. 1 cylinder. Place the thumb of one hand over the spark plug hole and rotate the crankshaft in direction of normal rotation until the compression stroke is reached. The compression stroke is indicated by a positive pressure inside the cylinder tending to lift the thumb off the spark plug hole. In this position both valves of no. 1 cylinder are closed.

Rotate the crankshaft opposite to its normal direction of rotation until it is approximately 35° before top center of the compression stroke of no. 1 cylinder.

Having determined that the engine is beginning the compression stroke on no. 1 cylinder, continue to rotate the crankshaft in its normal direction of rotation until the 25° advance timing mark on the front (propeller) face of the starter ring gear is in exact alignment with the small hole located at the two o'clock position on the front face of the starter housing.

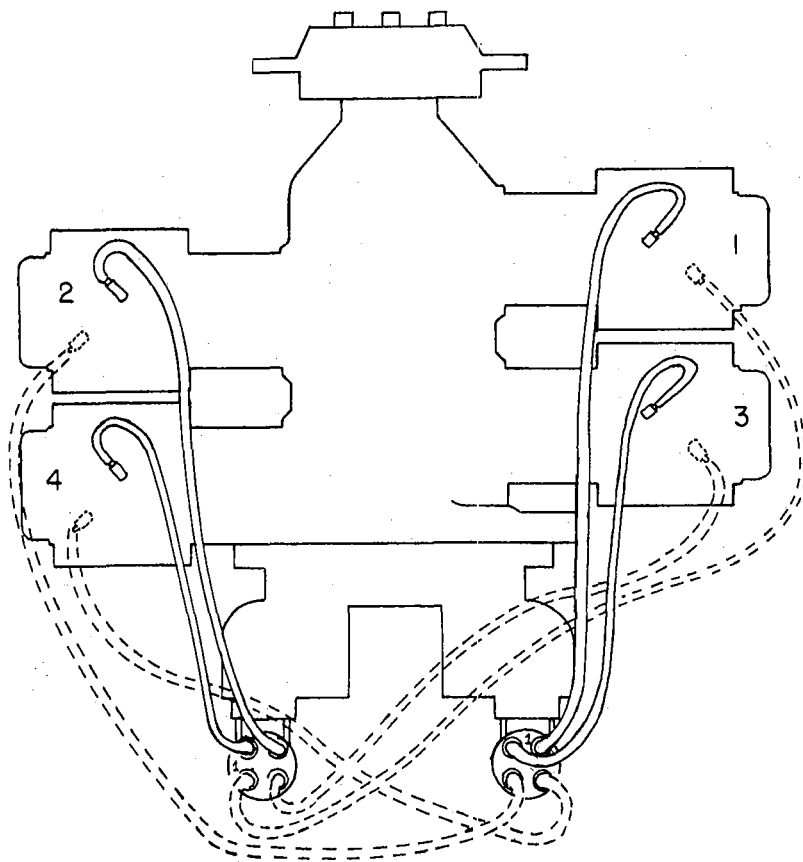

Figure 5-1. Ignition Wiring Diagram

NOTE

If the configuration of the engine cowling permits, the crankshaft can be aligned in the correct firing position for no. 1 cylinder by means of the advance timing marks on the rear face of the starter ring gear. This is done by attaching the ignition timing pointer (Lycoming Tool no. 64697) to the ring gear with the pointer accurately lined up with the timing mark on the rear face of the gear. The crankshaft is then rotated in its normal direction of rotation until the pointer is in alignment with the crankcase parting line.

With the magneto gear assembled on the right magneto, turn the magneto gear until the chamfered tooth on the distributor gear inside the magneto aligns with the white pointer as seen through the window in the front of the magneto cover.

Without allowing the gear to turn from this position, assemble the magneto with gasket on the engine. Secure magneto in place with washers and nuts; tighten nuts only finger tight.

Fasten ground wire of electric timing light to any unpainted metallic portion of the engine, and one of the positive wires of the timing light to a suitable terminal connected to the ground terminal connection of the right magneto. Then turn the engine crankshaft several degrees from the 25° BTC in direction opposite to that of normal rotation.

Turn on the switch of the timing light. The light should be lit. Turn the crankshaft very slowly in direction of normal rotation until the ignition timing pointer aligns with the parting flange of the crankcase, at which point the light should dim (or go out, on battery-powered timing lights). If not, turn the magneto in its mounting flange slots and repeat the procedure until the light dims at 25° before top dead center. Tighten the two mounting nuts and replace magneto inspection plug.

Install magneto impulse coupling adapter with gasket on left magneto mounting pad of the accessory housing.

NOTE

The impulse coupling magneto can be used only on the left side of the engine, when viewed from the rear, or accessory housing, end.

 **LYCOMING OPERATOR'S MANUAL**

SECTION 5

O-340-A1A

Remove inspection plug and turn magneto drive coupling until the white beveled tooth on the magneto gear aligns with the pointer.

NOTE

In order to turn the shaft on the impulse coupling magneto, depress the pawl on the impulse coupling with the finger.

Place magneto gasket over mounting studs and secure left magneto in place with washers and nuts; tighten nuts only finger tight.

Connect the other positive wire of the timing light to a suitable terminal connected to the ground terminal connection of the left magneto and time the magneto in the same manner as described for the right magneto.

NOTE

The crankshaft should not be rotated more than 35° in direction opposite normal rotation, as the pawl on the impulse coupling will engage with the stop pin and late timing will be indicated through the impulse coupling mechanism. If this should happen, rotate engine in normal direction until sharp click is heard, which will indicate that impulse coupling has passed through firing position; then turn crankshaft in direction opposite normal rotation to approximately 35° before top center and proceed with timing check.

After both magnetos have been timed, leave the timing light wires connected and re-check magneto timing as previously described to make sure that both magnetos are set to fire together. If timing is correct, both timing lights will dim simultaneously when the advance timing marks on the front of the engine are in exact alignment. If the breaker points open too early, loosen the mounting nuts and rotate the magneto clockwise. If the breaker points open too late, rotate the magneto counterclockwise.

After magnetos have been properly timed, clean the breaker points to remove any trace of oil or dirt. Replace breaker cover and lock the retaining screws together with lockwire.

NOTE

Breaker points on Bendix Scintilla S4LN type magnetos are not to be adjusted to a given clearance. For proper S4LN magneto adjustments, refer to Scintilla's instructions.

Removal of Cylinder Assembly -

- a. Remove exhaust manifold.
- b. Remove rocker box drain tube, intake pipe, baffles, priming lines, and any clips that interfere with the removal of cylinder.
- c. Disconnect ignition cable and remove spark plugs. Remove rocker box cover and rotate crankshaft until piston is approximately at top center of the compression stroke. This approximate position may be located by observing top of the piston through the spark plug hole and also watching the valve action.
- d. Remove valve rockers by sliding valve rocker shaft out of the cylinder head.
- e. Remove push rods by grasping ball end and pulling rod out of shroud tube. Detach shroud tube springs and lockplate and pull shroud tubes out through holes in cylinder head.
- f. Remove cylinder base nuts and plates and remove cylinder by pulling cylinder directly away from crankcase. Be careful not to allow the piston to drop against the crankcase as the piston leaves the cylinder.

NOTE

The hydraulic tappets, push rods, rocker arms, and valves must be marked so that they can be assembled in the same location from which they were removed.

Removal of Valves and Valve Springs from Cylinder - Place the cylinder over a block of wood so as to hold the valves in a closed position. Compress the valve springs using the valve spring compressor. Remove the split keys from the end of the valve stem. The valve springs and valve spring seats may now be removed from the cylinder head. Hold the valve stems so that the valves will not fall out and remove the cylinder from the holding block. The valves may now be removed from the inside of the cylinder.

Removal of Piston from Connecting Rod - Remove piston pin plugs from the piston. Insert piston pin puller through piston pin, assemble puller nut; then proceed to remove piston pin. Do not allow connecting rod to rest on the cylinder bore of the crankcase. Support with heavy rubber bands, discarded cylinder base oil ring seals, or any other non-marring means of support.

Removal of Hydraulic Tappet Sockets and Plunger Assemblies - The hydraulic tappet socket may usually be removed by inserting the forefinger into the concave end of the socket. The socket will usually stick to the finger firmly enough to be pulled out of the tappet body. If the socket cannot be removed in this manner, it may be removed by grasping the edge of the socket with a pair of needle nose pliers. However, care should be exercised to avoid scratching the socket. To remove the hydraulic tappet plunger assembly, use service tool 64941 or if not available, bend a hook in the end of a short piece of lock wire, insert the lock wire around the edge of the plunger assembly and turn the wire so that the hook engages the spring of the plunger assembly. Draw the plunger assembly out of the tappet body by pulling gently on the wire.

Cleaning and Inspection of Hydraulic Tappet Plunger Assembly - Disassemble hydraulic tappet plunger assembly by grasping the tube end of the plunger assembly in one hand and the spring end in the other. Remove the plunger by twisting the spring end of the plunger assembly in a clockwise direction and pulling the plunger out of the tube.

CAUTION

Do not allow parts of two or more plunger assemblies to become mixed, as the parts of the plunger assembly are selectively fitted during manufacture and are not interchangeable.

Clean the plunger assembly by flushing with petroleum solvent. Work the plunger up and down while the unit is immersed in the solvent, holding the check valve off its seat by means of a copper wire or other relatively soft article inserted through the tube. Do not use a blast of air or pressure spray to clean the plunger assembly, as damage to the check valve and check valve seat may result.

Thoroughly dry the plunger assembly and start the plunger into the cylinder. Check the operation of the plunger assembly by depressing and releasing the plunger with one finger. On a serviceable plunger assembly, the plunger will spring back if pressure is released immediately after the plunger is depressed. This is caused by the air trapped inside the plunger assembly. If the plunger assembly, when pushed down by the finger, does not have a "springy" feel and stays at the bottom when released, the check valve is leaking, or the plunger assembly is worn and will not hold air under the plunger. If the plunger assembly fails to pass inspection as outlined above, clean the plunger assembly as directed in preceding paragraph and repeat the check. If the plunger assembly still fails to pass inspection, it should be rejected and replaced with a new plunger assembly.

NOTE

The above inspection procedure must be made with the plunger assembly absolutely dry and free from oil or cleaning solvent.

The plunger assembly should be reassembled without oil. This may be accomplished by placing the plunger in position, compressing the spring slightly, and at the same time twisting the spring end of the plunger in a clockwise direction until the spring is felt to click into place.

Assembly of Valves in Cylinder - Insert each valve stem in its respective guide. Place cylinder over a wood block so that the valves are held against the seats and assemble the lower spring seat, auxiliary valve spring and outer valve spring over the valve stem and guide. Place the upper spring seat on top of the springs.

NOTE

When installing valve springs, place the dampener end of spring toward cylinder. The dampener end of the spring may be identified as the end of the spring that has less spacing between the coils.

Using valve spring compressor, compress the valve springs and assemble the two valve keys into the groove around the upper end of the valve stem. Slowly release the pressure on the valve spring compressor and allow the upper spring seat to lock itself in place around the valve keys.

Assembly of Cylinder and Related Parts - Rotate crankshaft so that the connecting rod of the cylinder being assembled is at the top center position with both tappets on the low side of the cam in a position that corresponds with both valves closed.

Place each plunger assembly in its respective tappet body and assemble socket on top of plunger assembly.

Assemble piston so that the cylinder number stamped on the piston pin boss is toward the front end of the engine. The piston pin should be a hand push fit. If difficulty is experienced in inserting the piston pin, it is probably caused by carbon or burrs in the piston pin hole. During assembly always use a generous quantity of oil, both in the piston pin hole and on the piston pin.

Assemble one piston pin plug at each end of the piston pin and place a new cylinder base oil seal ring around the cylinder skirt. Coat piston and rings and the inside of the cylinder generously with oil.

Using a piston ring compressor, assemble the cylinder over the piston so that the intake and exhaust ports are toward the bottom of the engine. When the cylinder base flange is firmly seated against the crankcase, place a cylinder hold-down nut plate over each group of studs (upper and lower) and install the hold-down nuts; tighten each nut to proper torque (see Service Table of Limits SSP2070) and secure with lock wire.

Insert a new shroud tube oil seal on the crankcase end of each shroud tube and fit a new annular ring in the groove provided in the rocker box end of each shroud tube.

Install each shroud tube through the rocker box and seat the end firmly in the crankcase. Place a spacer, two springs, a lockplate, and nut over the stud provided in the rocker box and secure both shroud tubes in place. Bend the tang of the lockplate to prevent the nut and spring from loosening.

Assemble each push rod in its respective shroud tube, and assemble each rocker in its respective position by placing rocker between bosses and sliding valve rocker pin in place to retain rocker.

 **LYCOMING OPERATOR'S MANUAL**

O-340-A1A

SECTION 5

Be sure that the piston is at top center compression stroke and that both valves are closed. Check clearance between the valve stem tip and the valve rocker. In order to check this clearance, place the thumb of one hand on the valve rocker directly over the end of the push rod and push down so as to compress the hydraulic tappet spring. While holding the spring compressed, check valve clearance, which should be between .028 and .080 inch. If the clearance does not come within these limits, remove the push rod and insert a longer or shorter push rod as required to correct clearance. Push rods are made in four lengths; the shortest rod is marked with three grooves at one end, the next longer rod is marked with two grooves, the third rod is marked with one groove, and the longest rod is unmarked.

NOTE

Inserting a longer rod will cause a decrease in the valve clearance.

TROUBLE-SHOOTING

	Page
Failure of Engine to Start6-1
Failure of Engine to Idle Properly6-2
Low Power and Uneven Running6-2
Failure of Engine to Develop Full Power6-3
Rough Engine6-4
Low Oil Pressure6-4
High Oil Temperature6-5
Excessive Oil Consumption6-5
Cold Weather Difficulties6-6

SECTION 6

TROUBLE—SHOOTING

General - Experience has proven that the best method of “trouble-shooting” is to decide on the various possible causes of a given trouble and then to eliminate these causes one by one, beginning with the most probable. The following chart lists some of the more common engine troubles usually found in maintaining aircraft engines.

TROUBLE	PROBABLE CAUSE	REMEDY
Failure of Engine to Start	Lack of fuel	Check fuel system for leaks. Fill fuel tank. Clean dirty lines, strainers or fuel cocks.
	Underpriming	Prime with 2 or 3 strokes primer.
	Overpriming	Open throttle and “unload” engine by turning in counter-clockwise direction.
	Incorrect throttle setting	Open throttle to one-tenth of its range.
	Defective spark plugs	Clean and adjust or replace spark plug or plugs.
	Defective ignition wire	Check with electric tester, and replace any defective wires.
	Defective battery	Replace with charged battery.
	Improper operation of magneto breaker points	Clean points. Check internal timing of magnetos.

AVCO LYCOMING OPERATOR'S MANUAL

SECTION 6

O-340-A1A

TROUBLE	PROBABLE CAUSE	REMEDY
Failure of Engine to Start (Cont.)	Water in carburetor	Drain carburetor and fuel lines.
	Internal failure	Check oil sump strainer for metal particles. If found, complete overhaul of the engine may be indicated.
Failure of Engine to Idle Properly	Incorrect carburetor idle adjustment	Adjust throttle stop to obtain correct idle.
	Idle mixture	Adjust mixture - refer to Section 5, this handbook.
	Leak in the induction system	Tighten all connections in the induction system. Replace any parts that are defective.
	Low cylinder compression	Check condition of piston rings and valve seats.
	Faulty ignition system	Check entire ignition system
Low Power and Uneven Running	Mixture too rich; indicated by sluggish engine operation, red exhaust flame at night. Extreme cases indicated by black smoke from exhaust	Check primer shut-off valve for leakage. Readjustment of carburetor by authorized personnel is indicated.
	Mixture too lean; indicated by overheating or back-firing	Check fuel lines for dirt or other restrictions. Check fuel supply.
	Leaks in induction system	Tighten all connections. Replace defective parts.

AVCO LYCOMING OPERATOR'S MANUAL

O-340-A1A

SECTION 6

TROUBLE	PROBABLE CAUSE	REMEDY
Low Power and Uneven Running (Cont.)	Defective spark plugs	Clean or replace spark plugs.
	Poor fuel	Fill tank with fuel of recommended grade.
	Magneto breaker points not working properly	Clean points. Check internal timing of magnetos.
	Defective ignition wire	Check wire with electric tester. Replace defective wire.
	Improper ignition timing	Check magnetos for timing and synchronization.
	Defective spark plug terminal connectors	Replace connectors on spark plug wire.
	Incorrect valve clearance	Adjust valve clearance.
	Incorrect valve timing	Check valve timing.
Failure of Engine to Develop Full Power	Throttle lever out of adjustment	Adjust throttle lever.
	Leak in the induction system	Tighten all connections, and replace defective parts.
	Restriction in carburetor air scoop	Examine air scoop and remove restrictions.
	Improper fuel	Fill tank with recommended fuel.

 **LYCOMING OPERATOR'S MANUAL**

SECTION 6

O-340-A1A

TROUBLE	PROBABLE CAUSE	REMEDY
Failure of Engine to Develop Full Power (Cont.)	Faulty ignition	Tighten all connections. Check system with tester. Check ignition timing.
	Cracked engine mount	Replace or repair mount.
Rough Engine	Unbalanced propeller	Remove propeller and have it checked for balance.
	Defective mounting bushings	Install new mounting bushings.
	Malfunctioning engine	Check entire engine.
	Insufficient oil	Check oil supply.
Low Oil Pressure	Air lock or dirt in relief valve	Remove and clean oil pressure relief valve.
	Leak in suction line or pressure line	Check gasket between accy. housing and crankcase.
	Dirty oil strainers	Remove and clean oil strainers.
	High oil temperature	See "High Oil Temperature" in "Trouble" column.
	Defective pressure gage	Replace gage.
	Stoppage in oil pump intake passage	Check line for obstruction. Clean suction strainer.

AVCO LYCOMING OPERATOR'S MANUAL

O-340-A1A

SECTION 6

TROUBLE	PROBABLE CAUSE	REMEDY
High Oil Temperature	Insufficient air cooling	Check air inlet and outlet for deformation or obstruction.
	Insufficient oil supply	Fill oil sump to proper level.
	Low grade of oil	Replace with oil conforming to specification.
	Clogged oil lines or strainers	Remove and clean oil strainers.
	Excessive blow-by	Usually caused by worn or stuck rings. Complete overhaul required.
	Failing or failed bearing	Examine sump for metal particles. If found, overhaul of engine is indicated.
	Improper engine operation	Check entire engine.
	Defective temperature gage	Replace gage.
Excessive Oil Consumption	Low grade of oil	Fill tank with oil conforming to specification.
	Failing or failed bearing	Check sump for metal particles. If found, overhaul engine.
	Worn piston rings	Install new rings.
	Incorrect installation of piston rings	Install new rings.

 **LYCOMING OPERATOR'S MANUAL**

SECTION 6

O-340-A1A

TROUBLE	PROBABLE CAUSE	REMEDY
Cold Weather Difficulties	Cold oil	Move aircraft into a heated hangar. Heat oil.
	Inaccurate pressure readings	In extreme cold weather oil pressure readings up to approximately 100 lbs.do not necessarily indicate malfunctioning.
	Overpriming	Rotate crankshaft in counter-clockwise direction with throttle "FULL OPEN" and ignition switch "OFF".
	Weak battery	Install fully charged battery.

INSTALLATION AND STORAGE

	Page
Preparation for Installation	7-1
General	7-2
Inspection of Engine Mtg.	7-2
Attaching Engine to Mounts	7-2
Oil and Fuel Line Connections	7-2
Propeller Installation	7-2
Preparation of Carbs. and Fuel	
Injectors for Installation	7-2
Corrosion Prevention in Engines	
Installed in Inactive Aircraft	7-3

SECTION 7**INSTALLATION AND STORAGE**

1. PREPARATION OF ENGINE FOR INSTALLATION. Before installing an engine that has been prepared for storage, remove all dehydrator plugs, bags of desiccant and preservative oil from the engine. Preservative oil can be removed by removing the bottom spark plugs and turning the crankshaft three or four revolutions by hand. The preservative oil will then drain through the spark plug holes. Draining will be facilitated if the engine is tilted from side to side during the above operation. Preservative oil which has accumulated in the sump can be drained by removing the oil sump plug. Engines that have been stored in a cold place should be removed to an environment of at least 70°F. (21°C.) for a period of 24 hours before preservative oil is drained from the cylinders. If this is not possible, heat the cylinders with heat lamps before attempting to drain the engine.

After the oil sump has been drained, the plug should be replaced, safety-wired, and the sump refilled with lubricating oil. The crankshaft should again be turned several revolutions to saturate the interior of the engine with the clean oil. When installing spark plugs, make sure that they are clean, if not, wash them in clean petroleum solvent. Of course, there will be a small amount of preservative oil remaining in the engine, but this can cause no harm. However, after twenty-five hours of operation, the lubricating oil should be drained while the engine is hot. This will remove any residual preservative oil that may have been present.

CAUTION

Do not rotate the crankshaft of an engine containing preservative oil before removing the spark plugs, because if the cylinders contain any appreciable amount of the mixture, the resulting action, known as hydraulic, will cause damage to the engine. Also, any contact of the preservative oil with painted surfaces should be avoided.

AVCO LYCOMING OPERATOR'S MANUAL

SECTION 7

O-340-A1A

General - Should any of the dehydrator plugs, containing crystals of silica-gel or similar material, be broken during their term of storage or upon their removal from the engine, and if any of the contents should fall into the engine, that portion of the engine must be disassembled and thoroughly cleaned before using the engine. The oil strainers should be removed and cleaned in gasoline or some other hydrocarbon solvent. The fuel drain screen located in the fuel inlet of the carburetor or fuel injector should also be removed and cleaned in a hydrocarbon solvent. The operator should also note if any valves are sticking. If they are, this condition can be eliminated by coating the valve stem generously with a mixture of gasoline and lubrication oil.

Inspection of Engine Mounting - If the aircraft is one from which an engine has been removed, make sure that the engine mount is not bent or damaged by distortion or misalignment as this can produce abnormal stresses within the engine.

Attaching Engine to Mounts - See airframe manufacturer's recommendations for method of mounting the engine.

Oil and Fuel Line Connections - The oil and fuel line connections are called out on the accompanying installation drawings.

Propeller Installation - Consult the airframe manufacturer for information relative to propeller installation.

2. PREPARATION OF CARBURETORS AND FUEL INJECTORS FOR INSTALLATION.

Carburetors and fuel injectors that have been prepared for storage should undergo the following procedures before being placed in service.

Carburetor (MA-4-5) - Remove the fuel drain plug and drain preservative oil. Remove the fuel inlet strainer assembly and clean in a hydrocarbon solvent. Reinstall the fuel drain plug and fuel inlet strainer assembly.

Fuel Injector (Bendix) - Remove and clean the fuel inlet strainer assembly and reinstall. Inject clean fuel into the fuel inlet connection with the fuel outlets uncapped until clean fuel flows from the outlets. Do not exceed 15 psi inlet pressure.

AVCO LYCOMING OPERATOR'S MANUAL

O-340-A1A

SECTION 7

**CORROSION PREVENTION IN ENGINES INSTALLED
IN INACTIVE AIRCRAFT**

Corrosion can occur, especially in new or overhauled engines, on cylinder walls of engines that will be inoperative for periods as brief as two days. Therefore, the following preservation procedure is recommended for inactive engines and will be effective in minimizing the corrosion condition for a period up to thirty days.

NOTE

Ground running the engine for brief periods of time is not a substitute for the following procedure; in fact, the practice of ground running will tend to aggravate rather than minimize this corrosion condition.

- a. As soon as possible after the engine is stopped, move the aircraft into the hangar, or other shelter where the preservation process is to be performed.
- b. Remove sufficient cowling to gain access to the spark plugs and remove both spark plugs from each cylinder.
- c. Spray the interior of each cylinder with approximately (2) ounces of corrosion preventive oil while cranking the engine about five (5) revolutions with the starter. The spray gun nozzle may be placed in either of the spark plug holes.
- d. Consult the latest edition of Service Letter No. L180 for detailed information on preservation for active and stored aircraft.

NOTE

Spraying should be accomplished using an airless spray gun (Spraying Systems Co., "Gunjet" Model 24A-8395 or equivalent). In the event an airless spray gun is not available, personnel should install a moisture trap in the air line of a conventional spray gun and be certain oil is hot at the nozzle before spraying cylinders.

- e. With the crankshaft stationary, again spray each cylinder through the spark plug holes with approximately two ounces of corrosion preventive oil. Assemble spark plugs and do not turn crankshaft after cylinders have been sprayed.

 **LYCOMING OPERATOR'S MANUAL**

SECTION 7

O-340-A1A

The corrosion preventive oil to be used in the foregoing procedure should conform to specification MIL-L-6529, Type 1 heated to 200°F./220°F. (93°C./104°C.) spray nozzle temperature. It is not necessary to flush preservative oil from the cylinder prior to flying the aircraft. The small quantity of oil coating the cylinders will be expelled from the engine during the first few minutes of operation.

NOTE

Oils of the type mentioned are to be used in Avco Lycoming aircraft engines for corrosion prevention only, and not for lubrication. See the latest edition of Avco Lycoming Service Instruction No. 1014 and Service Bulletin No. 318 for recommended lubricating oil.

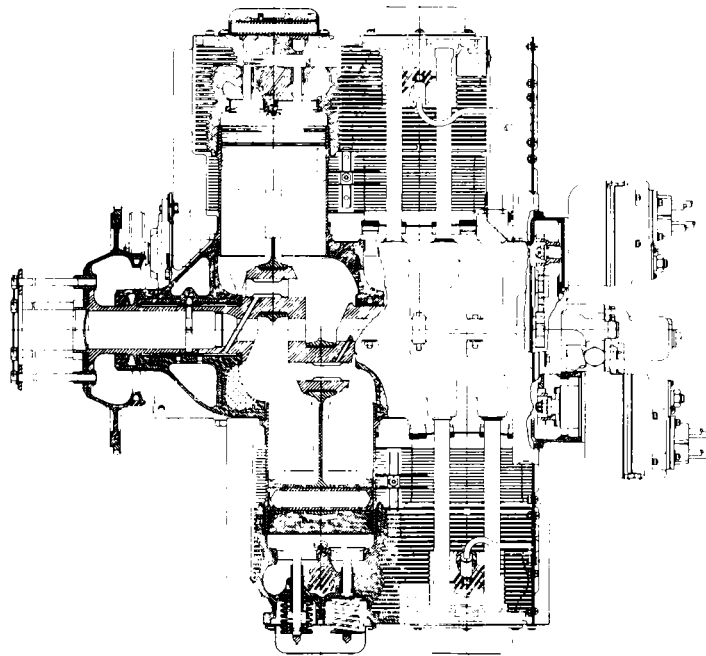

Figure 7-1. Longitudinal Section - O-340-A1A

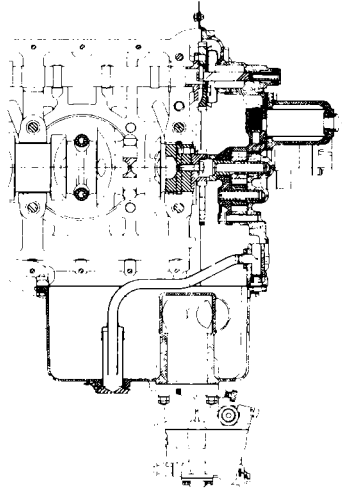

Figure 7-2. Accessory Drive Section - O-340-A1A

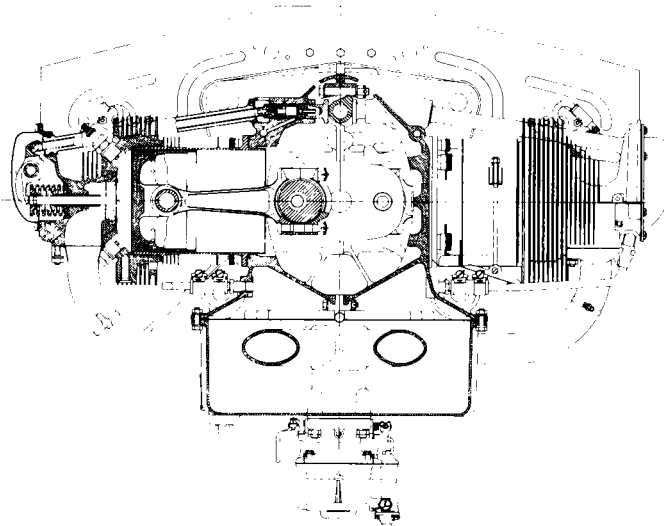

Figure 7-3. Transverse Section - O-340-A1A

TABLES

	Page
Table of Limits	8-1
Fixed Wing Only	8-2
Flight Test After Top Overhaul	8-3
Full Throttle HP at Altitude	8-4
Table of Speed Equivalents	8-4
Centigrade-Fahrenheit Conversion	8-5
Inch-Fractions Conversions	8-6

SECTION 8

TABLES

FOR TIGHTENING TORQUE RECOMMENDATIONS AND INFORMATION CONCERNING TOLERANCES AND DIMENSIONS THAT MUST BE MAINTAINED IN AVCO LYCOMING AIRCRAFT ENGINES, CONSULT LATEST EDITION OF SPECIAL SERVICE PUBLICATION NO. SSP2070.

CONSULT LATEST EDITION OF SERVICE INSTRUCTION NO. 1029 AND NO. 1150 FOR INFORMATION PERTINENT TO CORRECTLY INSTALLING CYLINDER ASSEMBLY.

FIXED WING ONLY																	
GROUND RUN AFTER TOP OVERHAUL OR CYLINDER CHANGE WITH NEW RINGS						GROUND RUN											
(DO NOT USE AFTER MAJOR OVERHAUL)																	
Type Aircraft _____						Registration No. _____											
Aircraft No. _____						Owner _____											
Engine Model _____ S/N _____						Date _____											
Run-Up By _____																	
1. Avoid dusty location and loose stones.						1. Visually inspect engine(s)											
2. Head aircraft into wind.						2. Check oil level(s)											
3. All cowling should be in place, cowl flaps open.																	
4. Accomplish ground run in full flat pitch.																	
5. Never exceed 200°F. oil temperature.																	
6. If cylinder head temperatures reach 400°F. shut down and allow engine to cool before continuing.																	
Time	RPM	MAP	Temperature				Pressure				Fuel Flow						
			L.oil	R.oil	L.cyl	R.cyl	L.oil	R.oil	L.fuel	R.fuel	L.carb	R.carb	Amb.	Air	Left	Right	
5 min	1000																
10 min	1200																
10 min	1300																
5 min	1500																
5 min	1600																
5 min	1700																
5 min	1800																
Mag. Check			Adjustment Required						After Completion of Ground Run								
Power Check									1. Visually inspect engine(s)								
Idle Check									2. Check oil level(s)								

**FLIGHT TEST AFTER TOP OVERHAUL
OR CYLINDER CHANGE WITH NEW RINGS**

1. Test fly aircraft one hour.
2. Use standard power for climb, and at least 75% power for cruise.
3. Make climb shallow and at good airspeed for cooling.
4. Record engine instrument readings during climb and cruise.

Tested by _____

FLIGHT TEST RECORD

Time (Climb) Cruise	RPM		MAP		Temperature		Pressure		Temperature		Fuel Flow			
	L.oil	R.oil	L.cy	R.cy	L.oil	R.oil	L.fuel	R.fuel	L.carb	R.carb	Amb.	Air	Left	Right

Adjustments Required After Flight

After Test Flight

1. Make careful visual inspection of engine(s).
2. Check oil level(s).
3. If oil Consumption is excessive, (see operator's manual for limits), remove spark plugs and check cylinder barrels for scoring.

**FULL THROTTLE HP AT ALTITUDE
(Normally Aspirated Engines)**

Altitude Ft.	% S. L. H. P.	Altitude Ft.	% S. L. H. P.	Altitude Ft.	% S. L. H. P.
0	100	10,000	70.8	19,500	49.1
500	98.5	11,000	68.3	20,000	48.0
1,000	96.8	12,000	65.8	20,500	47.6
2,000	93.6	13,000	63.4	21,000	46.0
2,500	92.0	14,000	61.0	21,500	45.2
3,000	90.5	15,000	58.7	22,000	44.0
4,000	87.5	16,000	56.5	22,500	43.3
5,000	84.6	17,000	54.3	23,000	42.2
6,000	81.7	17,500	53.1	23,500	41.4
7,000	78.9	18,000	52.1	24,000	40.3
8,000	76.2	18,500	51.4	24,500	39.5
9,000	73.5	19,000	50.0	25,000	38.5

TABLE OF SPEED EQUIVALENTS

Sec./Mi.	M. P. H.	Sec./Mi.	M. P. H.	Sec./Mi.	M. P. H.
72.0	50	24.0	150	14.4	250
60.0	60	22.5	160	13.8	260
51.4	70	21.2	170	13.3	270
45.0	80	20.0	180	12.8	280
40.0	90	18.9	190	12.4	290
36.0	100	18.0	200	12.0	300
32.7	110	17.1	210	11.6	310
30.0	120	16.4	220	11.2	320
27.7	130	15.6	230	10.9	330
25.7	140	15.0	240	10.6	340

AVCO LYCOMING OPERATOR'S MANUAL

O-340-A1A

SECTION 8

CENTIGRADE—FAHRENHEIT CONVERSION TABLE

Example: To convert 20°C. to Fahrenheit, find 20 in the center column headed (F—C); then read 68.0°F. in the column (F) to the right. To convert 20°F. to Centigrade; find 20 in the center column and read -6.61°C. in the (C) column to the left.

C	F—C	F	C	F—C	F
-56.7	-70	-94.0	104.44	220	428.0
-51.1	-60	-76.0	110.00	230	446.0
-45.6	-50	-58.0	115.56	240	464.0
-40.0	-40	-40.0	121.11	250	482.0
-34.0	-30	-22.0	126.67	260	500.0
-28.9	-20	-4.0	132.22	270	518.0
-23.3	-10	14.0	137.78	280	536.0
-17.8	0	32.0	143.33	290	554.0
-12.22	10	50.0	148.89	300	572.0
-6.67	20	68.0	154.44	310	590.0
-1.11	30	86.0	160.00	320	608.0
4.44	40	104.0	165.56	330	626.0
10.00	50	122.0	171.11	340	644.0
15.56	60	140.0	176.67	350	662.0
21.11	70	158.0	182.22	360	680.0
26.67	80	176.0	187.78	370	698.0
32.22	90	194.0	193.33	380	716.0
37.78	100	212.0	198.89	390	734.0
43.33	110	230.0	204.44	400	752.0
48.89	120	248.0	210.00	410	770.0
54.44	130	266.0	215.56	420	788.0
60.00	140	284.0	221.11	430	806.0
65.56	150	302.0	226.67	440	824.0
71.00	160	320.0	232.22	450	842.0
76.67	170	338.0	257.78	460	860.0
82.22	180	356.0	243.33	470	878.0
87.78	190	374.0	248.89	480	896.0
93.33	200	392.0	254.44	490	914.0
98.89	210	410.0	260.00	500	932.0

INCH FRACTIONS CONVERSIONS
Decimals, Area of Circles and Millimeters

Inch Fraction	Decimal Equiv.	Area Sq. In.	MM. Equiv.	Inch Fraction	Decimal Equiv.	Area Sq. In.	MM Equiv.
1/64	.0156	.0002	.397	1/2	.5	.1964	12.700
1/32	.0312	.0008	.794	17/32	.5312	.2217	13.494
3/64	.0469	.0017	1.191	35/64	.5469	.2349	13.891
1/16	.0625	.0031	1.587	9/16	.5625	.2485	14.288
3/32	.0937	.0069	2.381	19/32	.5937	.2769	15.081
7/64	.1094	.0094	2.778	39/64	.6094	.2916	15.478
1/8	.125	.0123	3.175	5/8	.625	.3068	15.875
5/32	.1562	.0192	3.969	21/32	.6562	.3382	16.669
11/64	.1719	.0232	4.366	43/64	.6719	.3545	17.065
3/16	.1875	.0276	4.762	11/16	.6875	.3712	17.462
7/32	.2187	.0376	5.556	23/32	.7187	.4057	18.256
15/64	.2344	.0431	5.593	47/64	.7344	.4235	18.653
1/4	.25	.0491	6.350	3/4	.75	.4418	19.050
9/32	.2812	.0621	7.144	25/32	.7812	.4794	19.844
19/64	.2969	.0692	7.540	51/64	.7969	.4987	20.241
5/16	.3125	.0767	7.937	13/16	.8125	.5185	20.637
11/32	.3437	.0928	8.731	27/32	.8437	.5591	21.431
23/64	.3594	.1014	9.128	55/64	.8594	.5800	21.828
3/8	.375	.1105	9.525	7/8	.875	.6013	22.225
13/32	.4062	.1296	10.319	29/32	.9062	.6450	23.019
27/64	.4219	.1398	10.716	59/64	.9219	.6675	23.416
7/16	.4375	.1503	11.112	15/16	.9375	.6903	23.812
15/32	.4687	.1725	11.906	31/32	.9687	.7371	24.606
31/64	.4844	.1842	12.303	63/64	.9844	.7610	25.003